

Moria Gate Cave Entrance Steps

West Coast



LOCALITY PLAN

NTS

NZTM 1532735mE 5443866mN

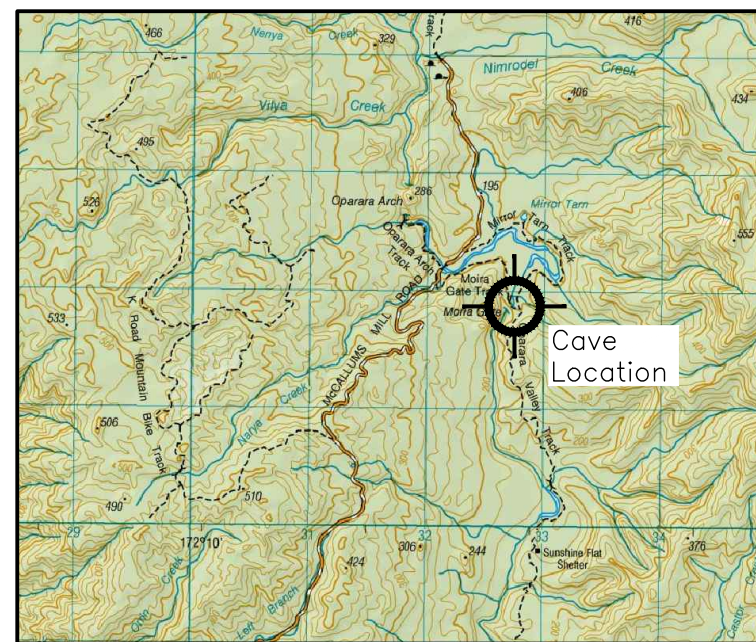

ENLARGED LOCATION PLAN

NTS

DESIGN PARAMETERS	
This structure is designed in accordance with SNZ HB 8630:2004 'Tracks and Outdoor Visitor Structures'	
Site Visitor Group (Tb 1)	SST

Drawing Index	
Sht No	Title
1	Cover Sheet
2	Cave Long Section
3	Section A
4	Section B
5	Section C



Department of Conservation
Te Papa Atawhai

New Zealand Government

NOTES:

1. The Contractor shall liaise with the DOC Works Officer when setting out new slabs to form steps, this shall be done before any cutting of slabs is carried out. Contractor to notify DOC Works Officer if the existing conditions are such that setting out of the steps as shown is not achievable

ORIGINAL SCALE = 100 MM

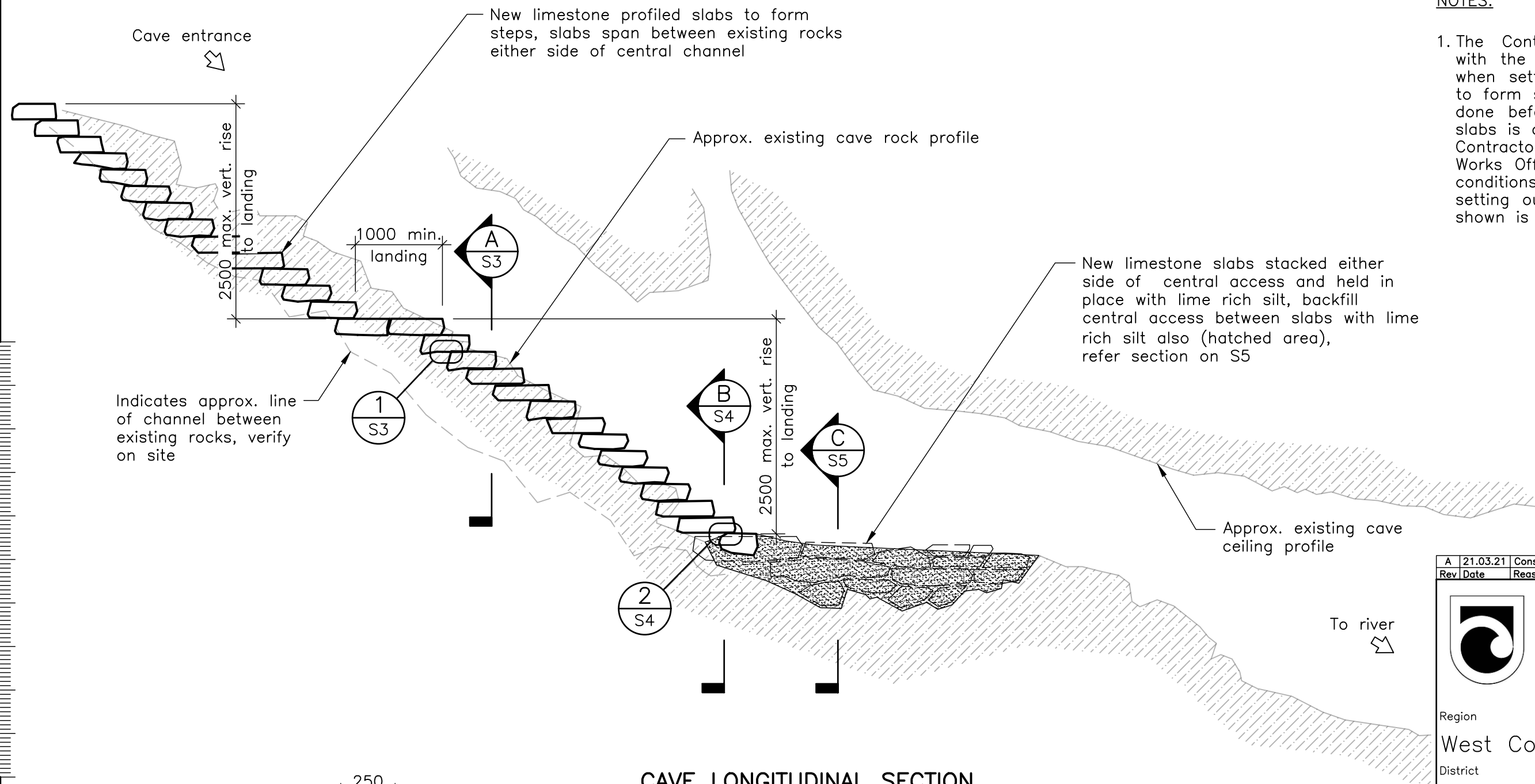

CAVE LONGITUDINAL SECTION

Scale: 1:50

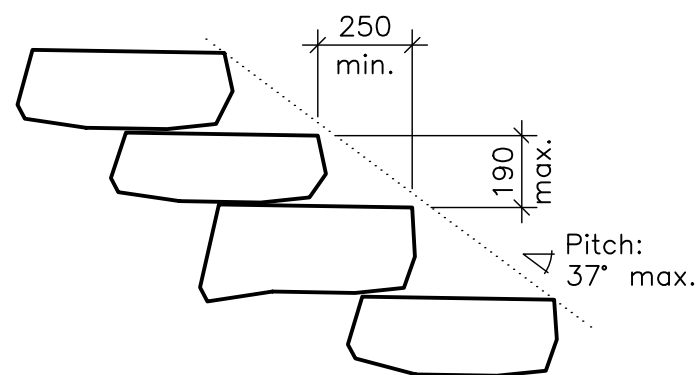

Note:

- Profiled slabs to be installed with a consistent rise each step
- Treads (slabs) must have an even surface and must not be muddy or rough
- The maximum width is to be achieved on site within the site parameters

TYPICAL SLAB STEPS SETTING OUT

Scale: 1:20

A	21.03.21	Construction
Rev	Date	Reason for issue
 Department of Conservation <i>Te Papa Atawhai</i>		
Region		
West Coast		
District		
Buller		
Project		
Moria Gate Cave Entrance Steps		
Sheet Title		
Cave Long Section		
Grid Reference (NZTM)		
1532735mE 5443866mN		
Func. Location		Tech ID
Designer	Drawn	Date
JD	JR	21.03.2021
Status	Sheet	Revision
Construction	2	A

DO NOT SCALE

ORIGINAL SCALE = 100 MM

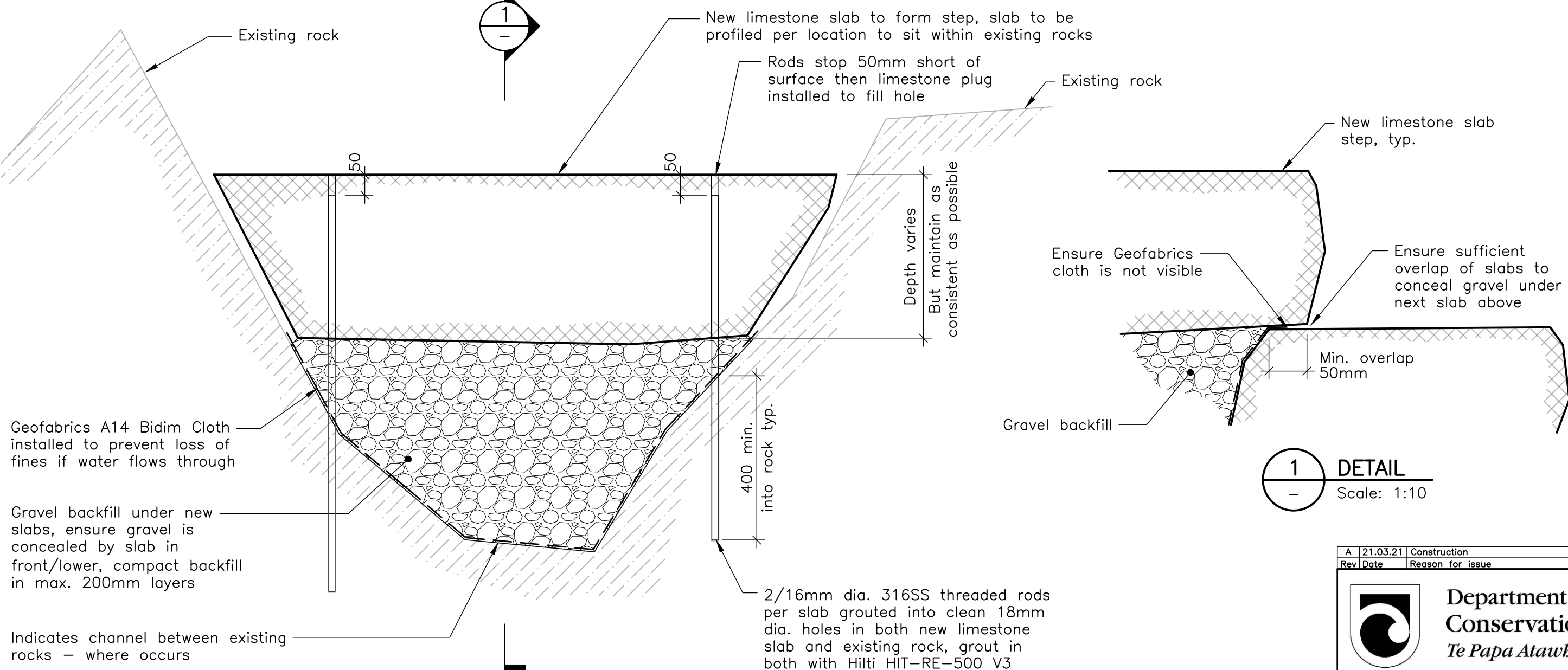
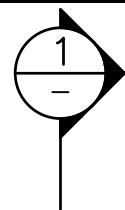

1
-
DETAIL
Scale: 1:10

- Construction notes:
- Drill and epoxy rods into base rock
 - Install Geofabrics cloth
 - Place gravel up to underside of next slab
 - Drill limestone slab through full depth to match rod centres and install slab over rods
 - Epoxy rods within slabs, stopping epoxy 50mm from slab surface
 - Install limestone plugs to fill hole – finish flush with slab surface, grind if necessary

A SECTION AT LIMESTONE SLAB – BRIDGING OPTION
S2 Scale: 1:10

NOTES:

1. Starter holes in rock and limestone slabs must be thoroughly blown out and cleaned with oil-free compressed air prior to grouting.

A	21.03.21	Construction
Rev	Date	Reason for issue
 Department of Conservation <i>Te Papa Atawhai</i>		
Region		
West Coast		
District		
Buller		
Project		
Moria Gate Cave Entrance Steps		
Sheet Title		
Section A		
Grid Reference (NZTM)		
1532735mE 5443866mN		
Func. Location		Tech ID
Designer	Drawn	Date
JD	JR	21.03.2021
Status	Sheet	Revision
Construction	3	A

ORIGINAL SCALE = 100 MM

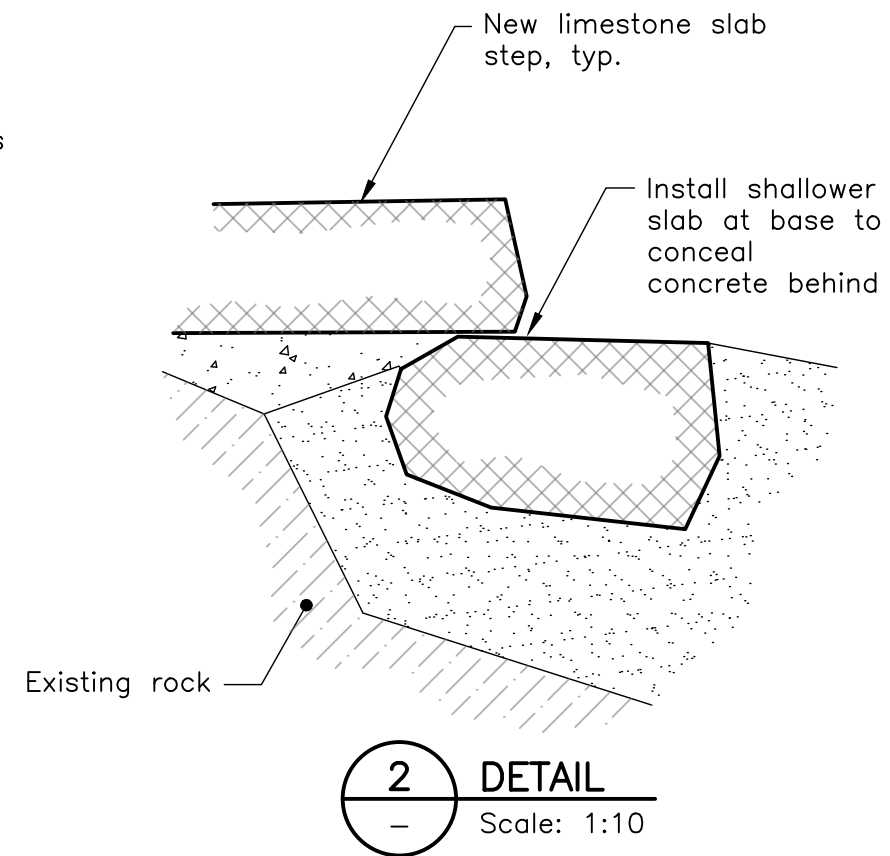
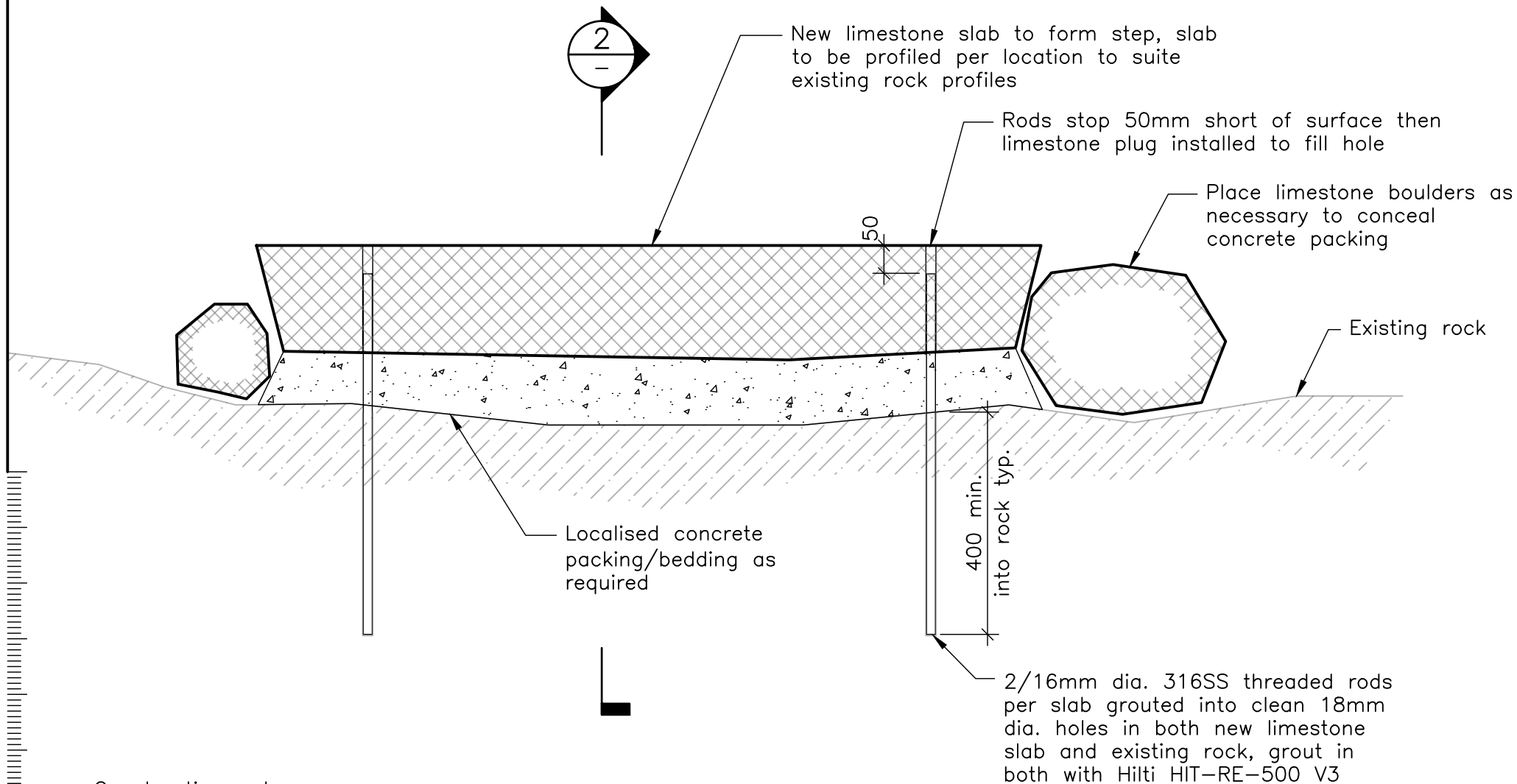

Construction notes:

- Drill and epoxy rods into base rock
- Install localised concrete packing up to required level
- Drill limestone slab through full depth to match rod centres and install slab over rods
- Epoxy rods within slabs, stopping epoxy 50mm from slab surface
- Install limestone plugs to fill hole – finish flush with slab surface, grind if necessary

B SECTION AT LIMESTONE SLAB – BEARING OPTION
S2 Scale: 1:10

NOTES:

1. Starter holes in rock and limestone slabs must be thoroughly blown out and cleaned with oil-free compressed air prior to grouting.

A	21.03.21	Construction
Rev	Date	Reason for issue
 Department of Conservation <i>Te Papa Atawhai</i>		
Region		
West Coast		
District		
Buller		
Project		
Moria Gate Cave Entrance Steps		
Sheet Title		
Section B		
Grid Reference (NZTM)		
1532735mE 5443866mN		
Func. Location		Tech ID
Designer	Drawn	Date
JD	JR	21.03.2021
Status	Sheet	Revision
Construction	4	A

ORIGINAL SCALE = 100 MM

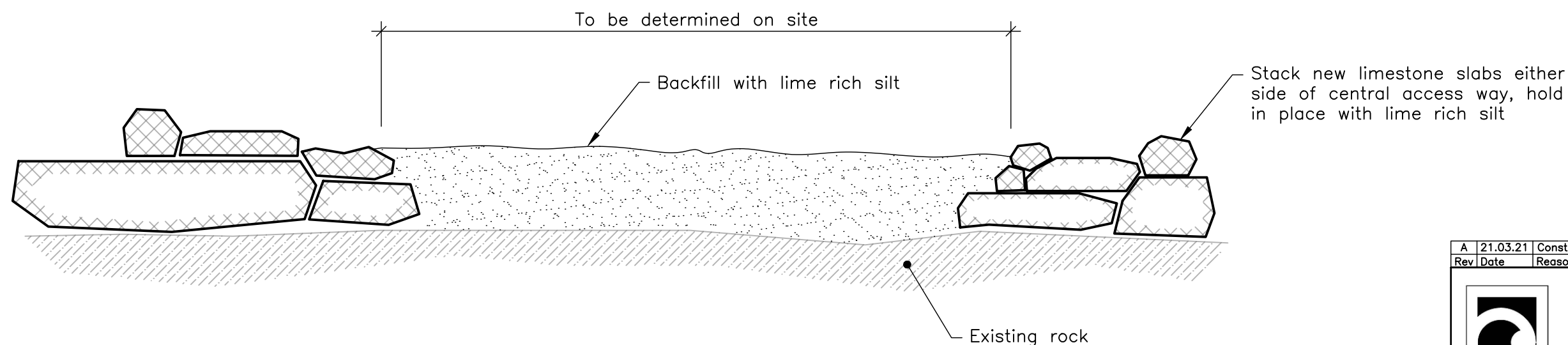

C SECTION
S2 Scale: 1:20

A	21.03.21	Construction
Rev	Date	Reason for issue
 Department of Conservation <i>Te Papa Atawhai</i>		
Region		
West Coast		
District		
Buller		
Project		
Moria Gate Cave Entrance Steps		
Sheet Title		
Section C		
Grid Reference (NZTM)		
1532735mE 5443866mN		
Func. Location		Tech ID
Designer	Drawn	Date
JD	JR	21.03.2021
Status	Sheet	Revision
Construction	5	A